

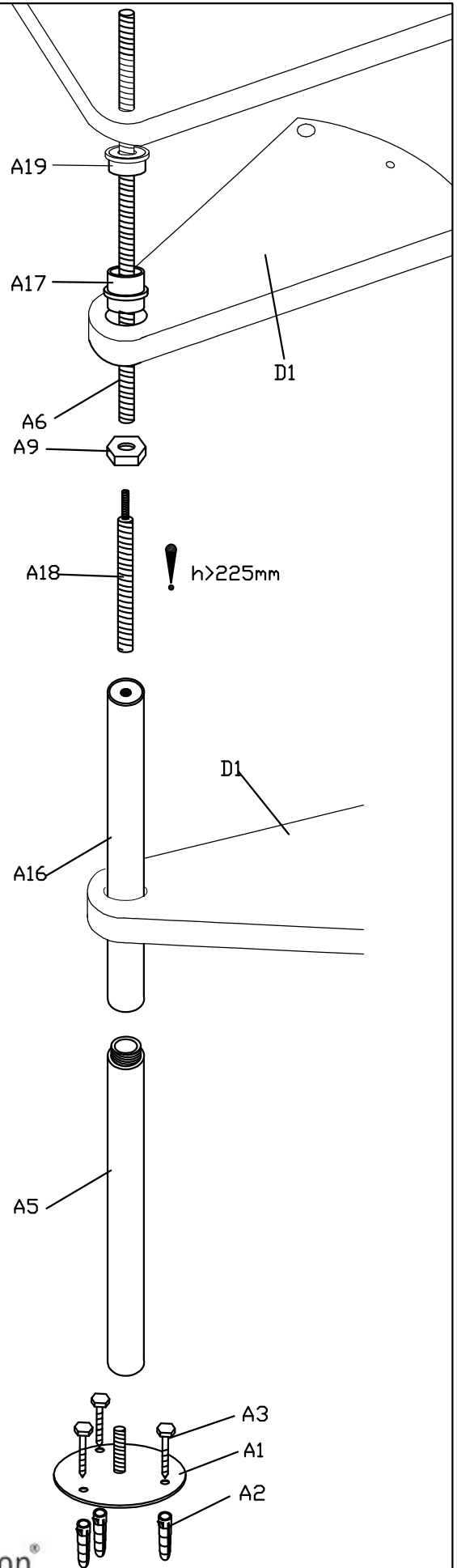

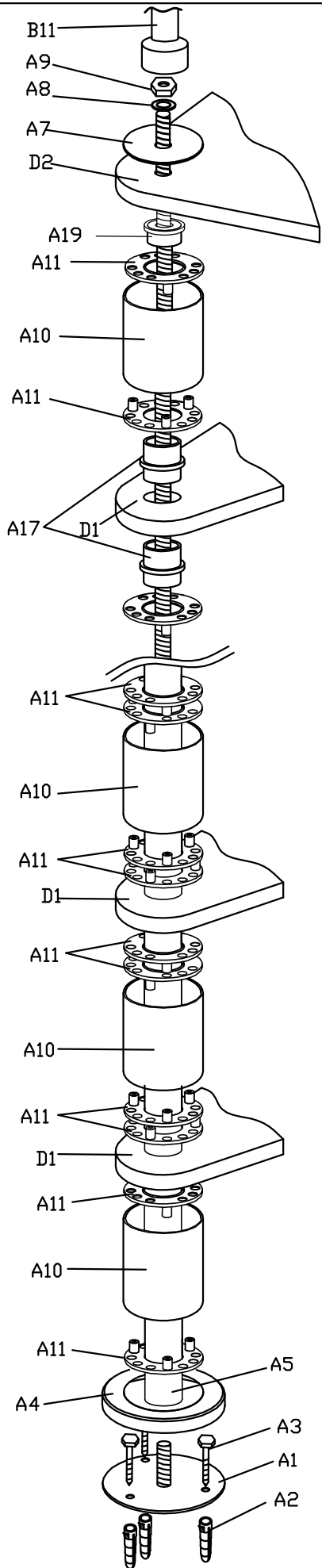

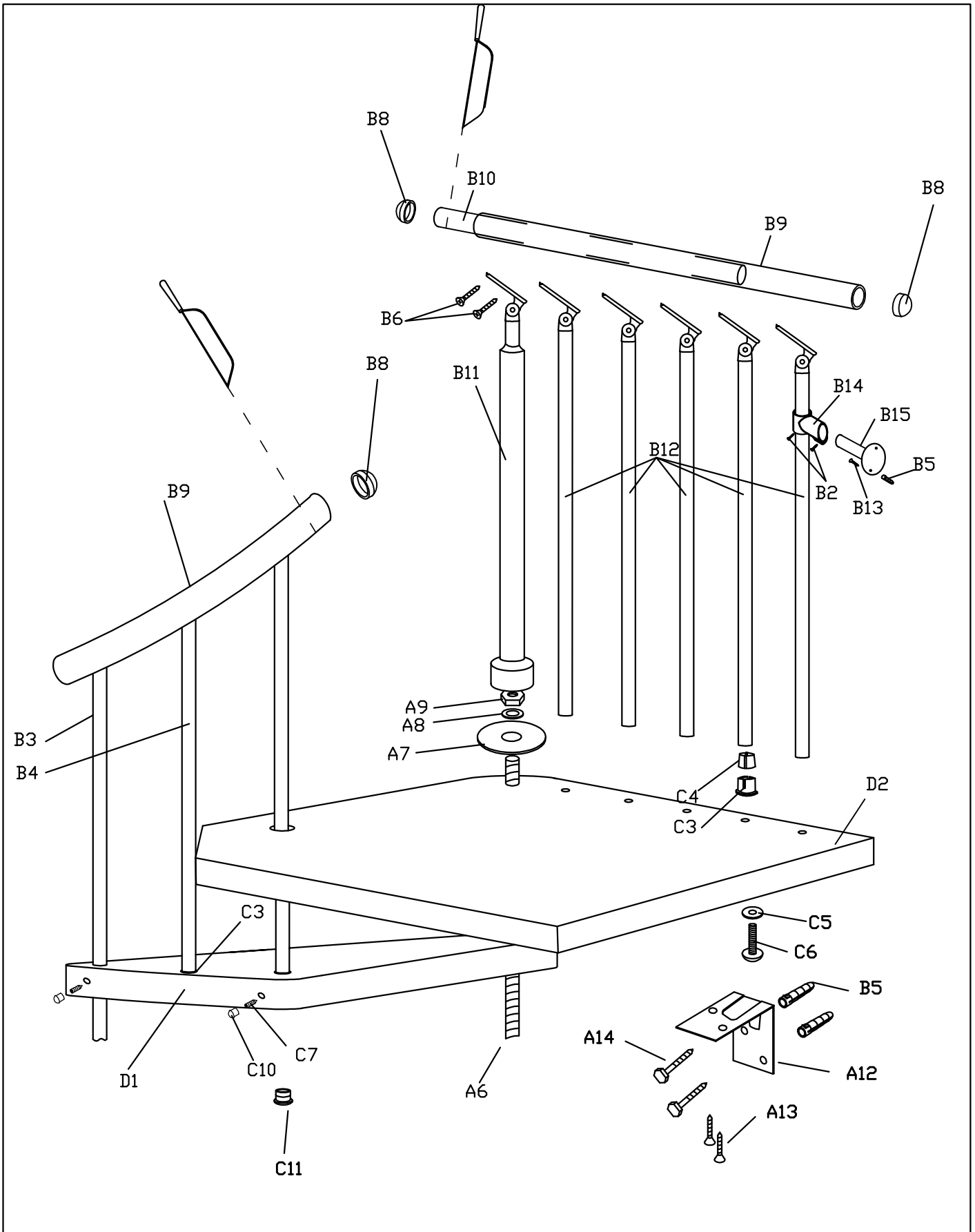





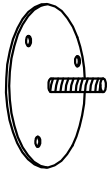

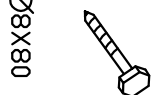
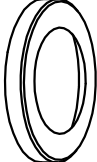
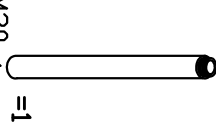
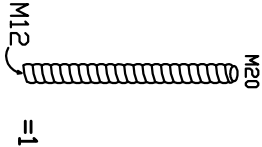



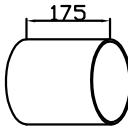
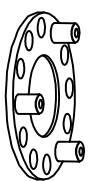
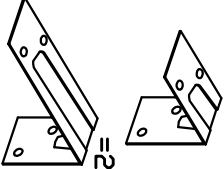

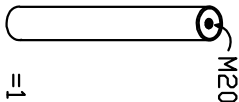

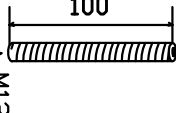

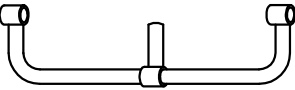
FLAMENCO G - D 120/140/160

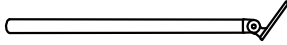
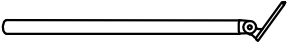

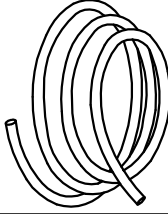

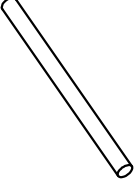
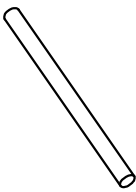
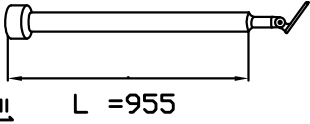
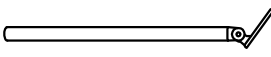







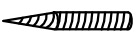

Um den Handlauf montieren zu können, muss die Zimmertemperatur über 16 Grad betragen

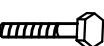

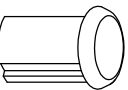
A1		=1
A2		=3
A3		=3
A4		=1
A5		=1
A6		=1
A7		=1
A8		=1
A9		=2
A10	 D120= Ø100 D140= Ø100 D160= Ø114	=13
A11	 D120= Ø100 D140= Ø100 D160= Ø114	=78
A12		=2
A13		=12
A14		=8
A16		=1
A17		=8
A18		=1
A19		=2
B1		=1
B2		=7
B3		=13
B4		=12
B5		=12
B6		=66
B7		=1
B8		=4
B9		=1
B10		=1
B11		=1
B12	 D120 D140 D160 =5 =6 =7	
B13		=2
B14		=2
B15		=1

FLAMENCO G - D 120/140/160

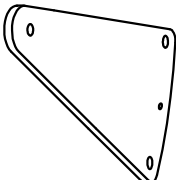
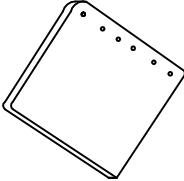

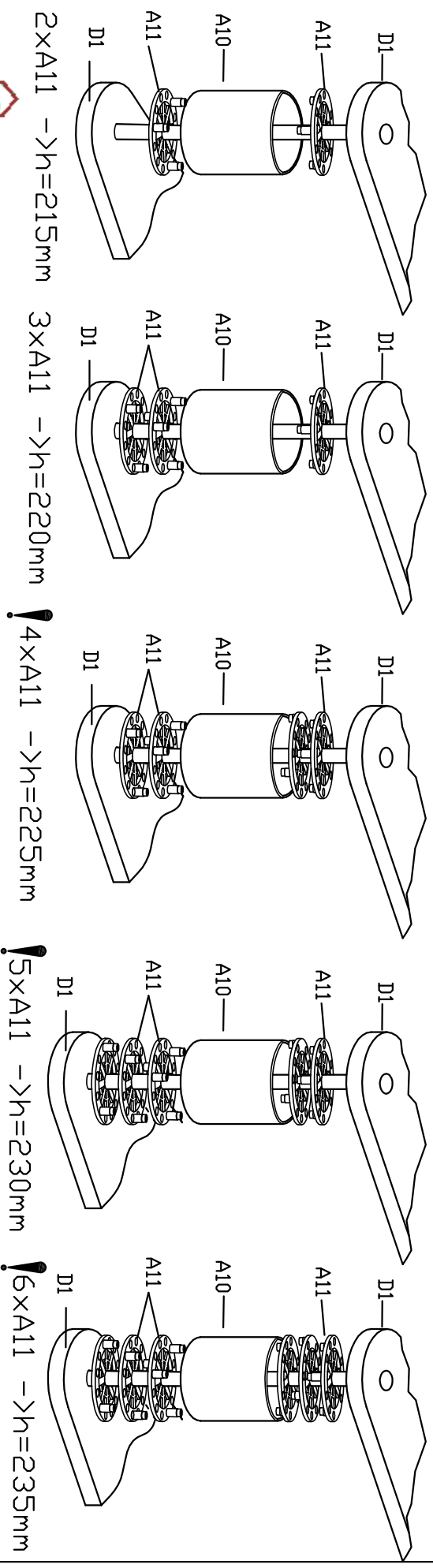





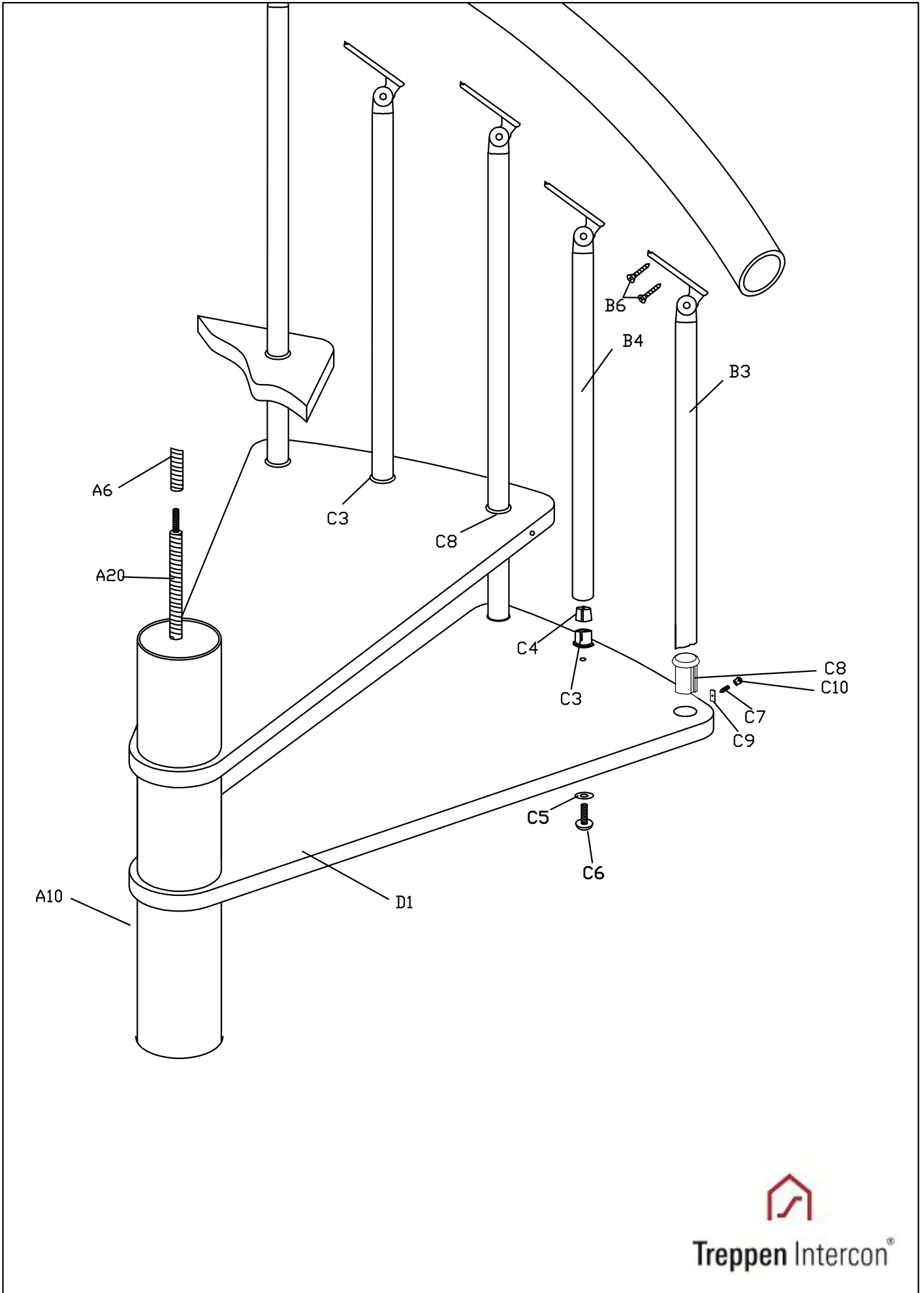

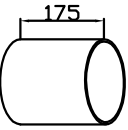

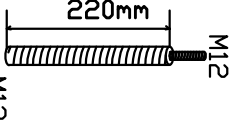
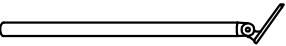
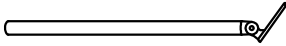
C1	 12 mm Ø12 =1	C2	 M8x80 =1	C3	 =20	C4	 =20	C5	 8 mm A8x24 =19	C6	 M8x60mm =19	C7	 M6x6 HEX 3=1 =25	C8	 =25	C9	 =25
C10	 =25	C11	 =12									D1	 =12	D2	 =1		

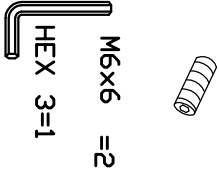
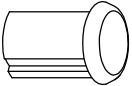

Treppen Interiors

FLAMENCO G - D 120/140/160

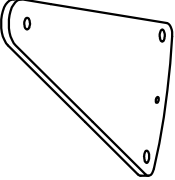

<p>A10</p>  <p>D120 = Ø100 D140 = Ø100 D160 = Ø114</p> <p>=1</p>	<p>A11</p>  <p>D120 = Ø100 D140 = Ø100 D160 = Ø114</p> <p>=6</p>	<p>A17</p>  <p>=2</p>	<p>A20</p>  <p>M12 220mm M12</p> <p>=1</p>	<p>B3</p>  <p>1155 mm</p> <p>=1</p>	<p>B4</p>  <p>1010 mm</p> <p>=1</p>	<p>B6</p>  <p>4X16</p> <p>=2</p>		<p>C7</p>  <p>M6x6 =2 HEX 3=1</p>	<p>C8</p>  <p>=2</p>	<p>C9</p>  <p>=2</p>	<p>C10</p>  <p>=2</p>	<p>C11</p>  <p>=1</p>
<p>C3</p>  <p>=1</p>	<p>C4</p>  <p>=1</p>	<p>C5</p>  <p>8 mm A8x24</p> <p>=1</p>	<p>C6</p>  <p>M8x60mm</p> <p>=1</p>	<p>D1</p>  <p>=1</p>								

FLAMENCO G - D 120/140/160

ZUSATZSTUFE





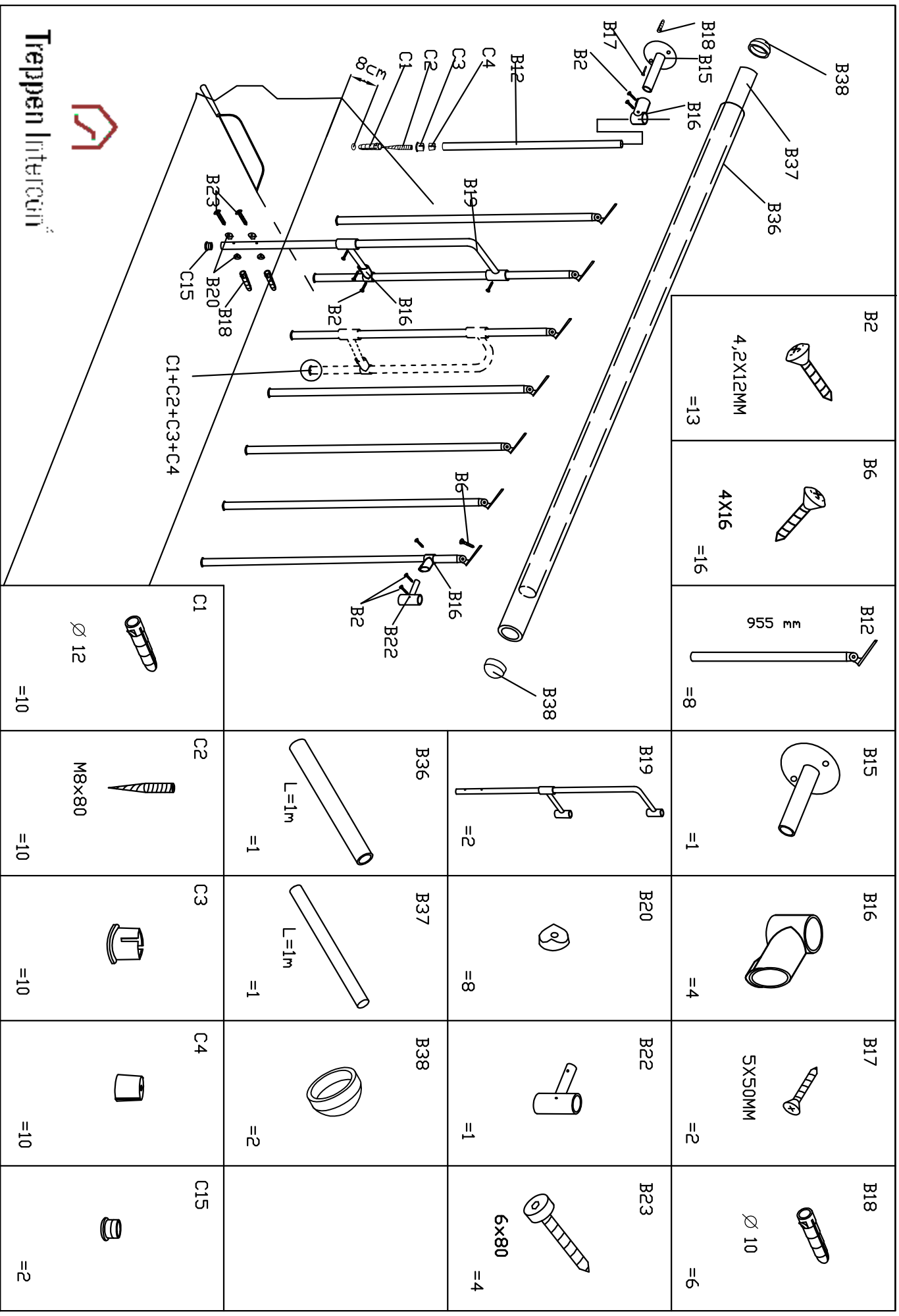









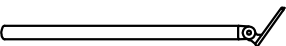



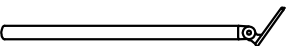
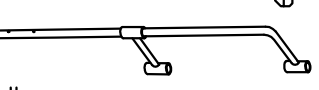



Treppen Intercom



Treppen Intercom



FLAMENCO G - Brüstungsgeländer L=100 cm

B2		4,2X12MM =13	B6		4X16 =16	B12		E 55 =8	B15		=1	B16		=4	B17		5X50MM =2	B18		Ø 10 =6
B12		E 55 =8	B19		=2	B20		=8	B22		=1	B23		6X80 =4						
C1		Ø 12 =10	B36		L=1m =1	B37		L=1m =1	B38		=2									
C2		M8x80 =10	C3		=10	C4		=10	C15		=2									
C3		=10	C4		=10	C15		=2												
C1+C2+C3+C4																				